

Data Sheet



Article number: 0108041

Description: Retaining ring JK 24 DIN 984

Measures

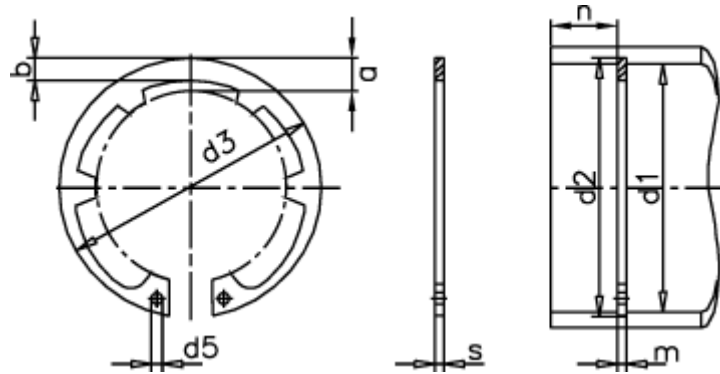

a max	= 4.2	FN kN	= 7.7	s	= 1.20
AN mm ²	= 46.3	FRg kN	= 4.6	t	= 0.60
b	= 2.6	FR kN	= 13.9	tol	= +0,21
d1	= 24	g	= 1.0	tol	= -0.06
d2	= 25.2	K kN-mm	= 28.4	tol	= +0,42-0,21
d3	= 26.9	m min	= 1.30	Tong	= ZGJ-2
d5 min	= 2.0	Nominal drive	= 1.8	Weight kg/1000	= 1.60
Description	= JK 24	Number of serrations	= 6		